

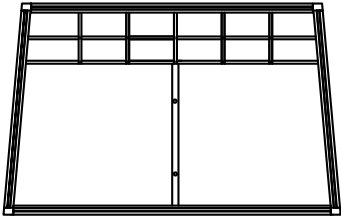



### Zweitürige Hundebox „Balu“ (26820 & 26825)

Nr.	Bauteil	Beschreibung	Stückzahl
1		Rückwand	1
2		Bodenplatte (MDF)	1
3		Seitenwand	2
4		obere Abdeckplatte (MDF)	1
5		Vorderwand	1
6		Trennwand	1
a		Schrauben	9
b		Schraubenschlüssel	1

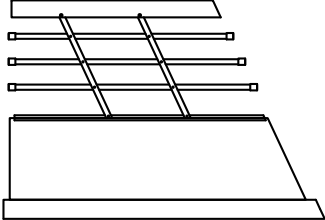
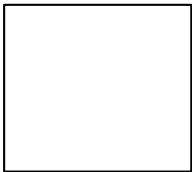
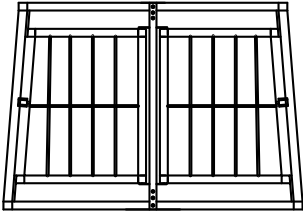
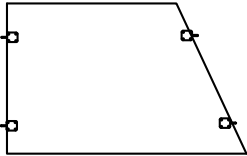

**Trennwand nachträglich  
in Schritt 6 montieren.**

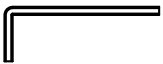
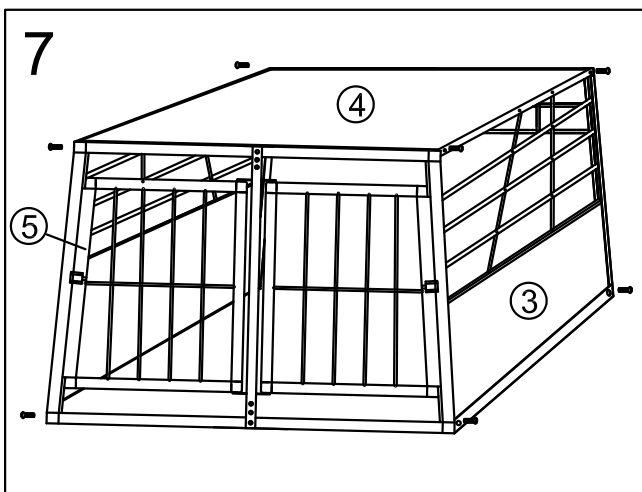
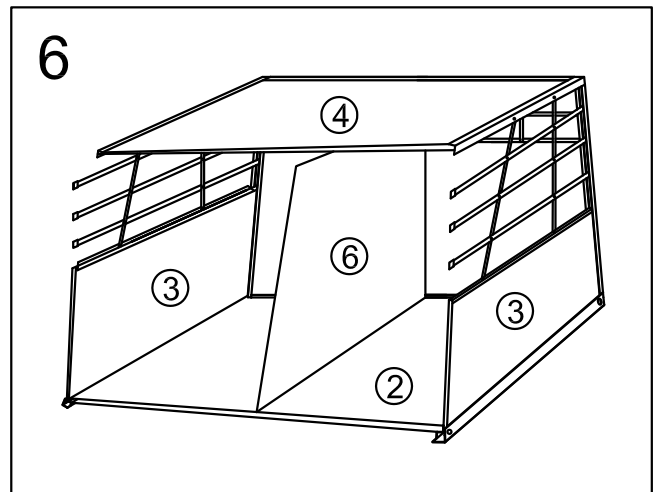
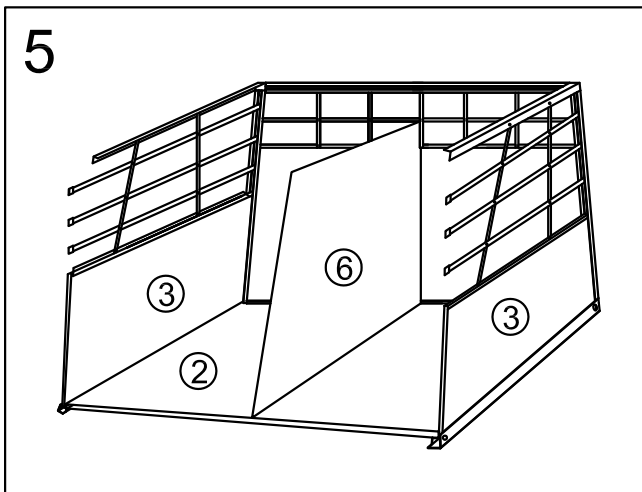
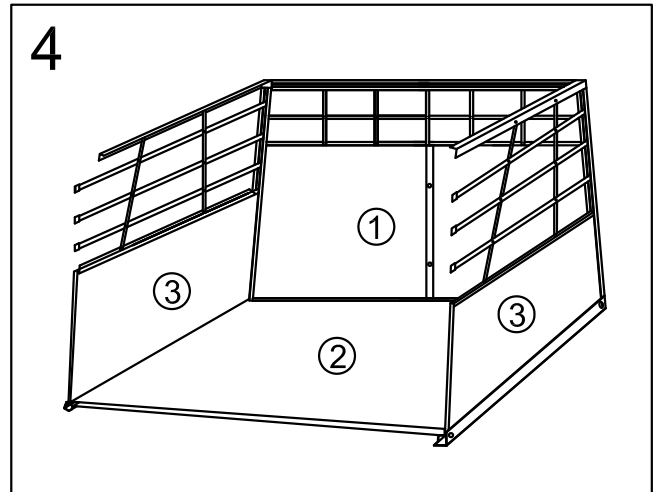
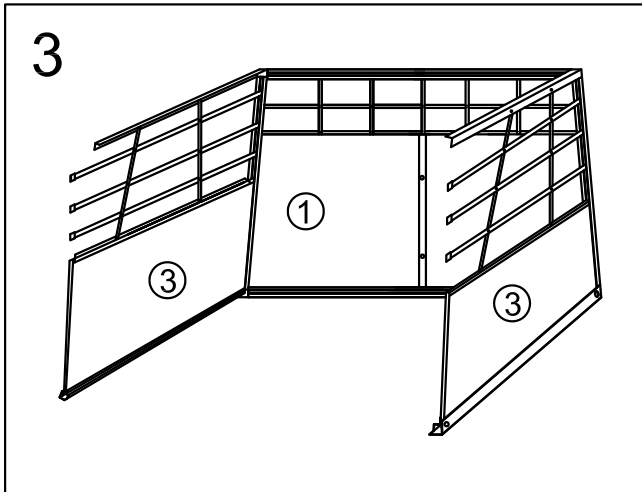
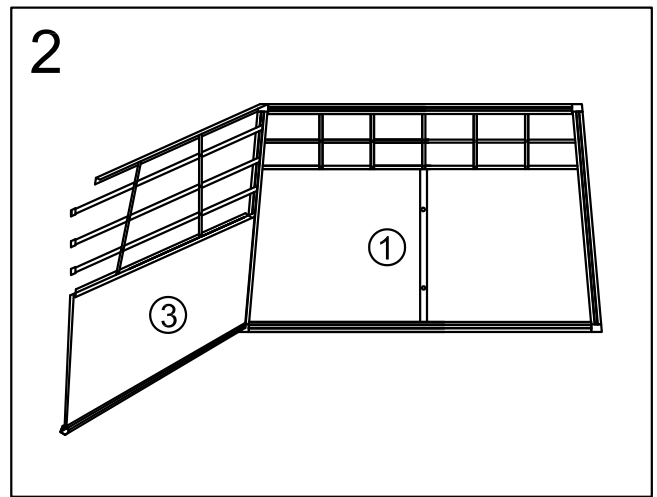
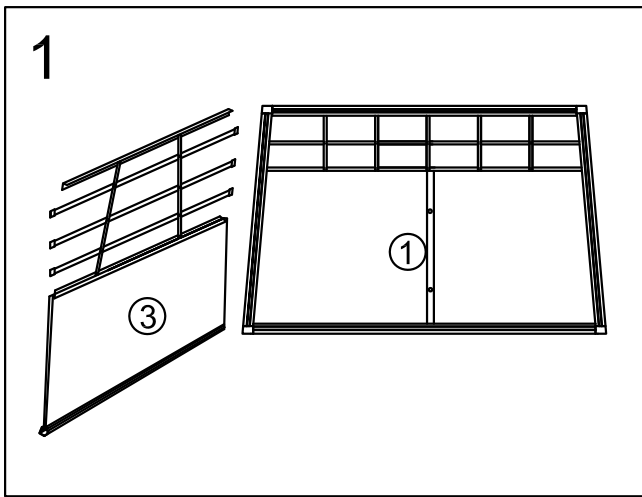
ELEFANT-Weidezaungeräte e.K.  
Ohrstedt-Bhf Nord 5  
25885 Wester-Ohrstedt  
Germany  
info@voss-group.eu